



DYNATEK DFS7-26 IGNITION with EFI REV-EXTEND

(P/N DFS7-26 FOR 2008+ YAMAHA RHINO 700 EFI)

8,000 RPM LIMIT (6,600 stock Rhino 700)

CAUTION: This ignition will increase the engine rev-limiter!

CAUTION: This ignition removes the reverse rev-limiter!

Congratulations on your purchase of a Dynatek ignition. Please take a moment to read these instructions completely before installing the ignition. The installation will only take about thirty minutes, but proper setup for your specific vehicle may take longer. The DynaFS ignition was designed to work best with the Dynatek coil (or stock coil) with the stock coil wire, plug cap, and spark plug. Use the stock resistor style spark plug cap and resistor spark plug.

Description

The DYNATEK Ignition Module for the 2008+ Yamaha Rhino 700efi is a piggyback add-on device that will increase the performance of the stock ignition and fuel injection system. This Module is designed to work in conjunction with the stock ECU, and will take complete control of the Ignition Timing while safely extending the fuel injection rev-limit. With the optional Dynatek CurveMaker software or the Dynatek DRSP-1 remote serial programmer, the ignition curves, fuel maps, rev-limits, and vehicle speed limits can be custom tailored for any application.

Installation

This kit includes: DynaFS ignition, electrical wiring, cable tie-wraps and instruction sheet. This is a complete kit, and includes everything needed to install the ignition. Route all wires carefully. Secure wires using the supplied cable-ties to ensure electrical wires do not chafe or touch anything sharp or hot.

1. Turn ignition key off, remove the seats and engine cover. Use the supplied 14" tie-wraps to install the ignition in the preferred location, under the passenger seat (picture 1).
2. Connect the Pickup Intercept and Vehicle Speed Intercept (both located near the passenger side of engine, towards the front of the engine compartment and near the floor board) by unplugging the stock connectors and connecting the matching DFS harness connectors in-line (picture 2).
3. Connect the Throttle Position Intercept (passenger side of throttle body) and Fuel Injector Intercept (top of engine) by unplugging the stock connectors and connecting the matching DFS harness connectors inline. Route the harness carefully using the supplied tie-wraps (picture 3).
4. Route the Coil Connections Harness under the intake towards the coil (picture 3). Connect the Ignition Coil Intercept (under the drivers seat) by removing the stock ORANGE wire (coil negative) and connecting it to the DFS ORANGE wire (picture 4).
5. Connect the DFS Ignition Coil Output ORANGE/BLACK wire to the ignition coil negative input (picture 4).
6. Connect the Ignition +12V Piggyback by removing the stock BROWN/RED wire and installing the DFS piggyback spade connector the coil positive, and then re-connecting the stock +12V lead to the DFS piggyback terminal. (picture 4).
7. Connect the DFS BLACK GROUND wire under the 8mm bolt at the back of the starter motor, directly under the throttle body. This can be easily seen from the passenger side of the engine (picture 5).
8. Finally, tie-wrap the DFS Accessory Wires away from the engine and away from sharp objects (picture 6).
9. Installation is complete! Double-check your wiring and secure all loose wires using tie-wraps.

Calibration

The DynaFS is pre-programmed with a single performance advance curve, +4° over stock, and an 8,000 RPM rev-limit. A quicker throttle response and increased power over the stock curve is achieved. For other advance curve information, see the attached Advance Chart. This ignition will allow the engine to rev to a higher RPM, and is adjustable to 10,000 RPM max by using the CurveMaker software. Because the rev limit is increased, the performance limits of other engine parts (valve train or piston for example) may be found. It may be necessary to replace these parts for best engine performance. The DFS7-26 is shipped from Dynatek with 0% adjustments to all of the fuel injection settings. For more information on fuel settings, see the section on Using the DRSP-1 Remote Programmer.

DYNATEK 164 S. Valencia St., Glendora, CA 91741 800-928-3962 www.dynaonline.com

2801379A

Picture 1:



Picture 2:

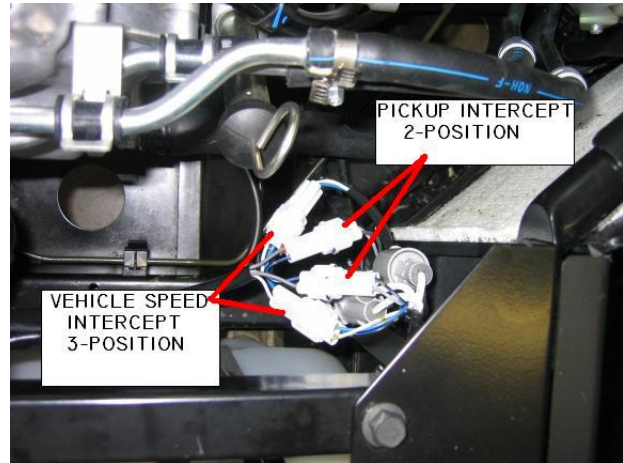

Picture 3:

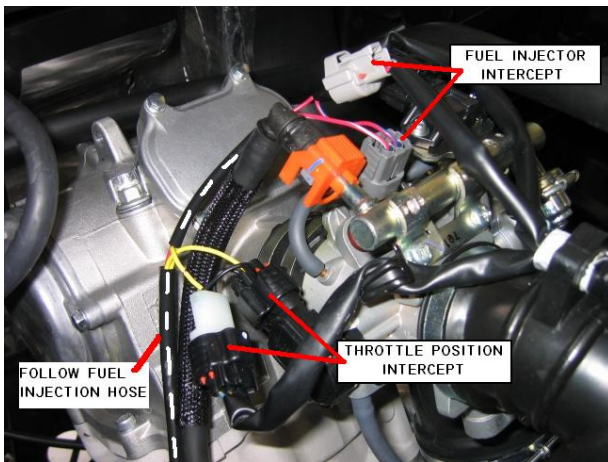

Picture 4:

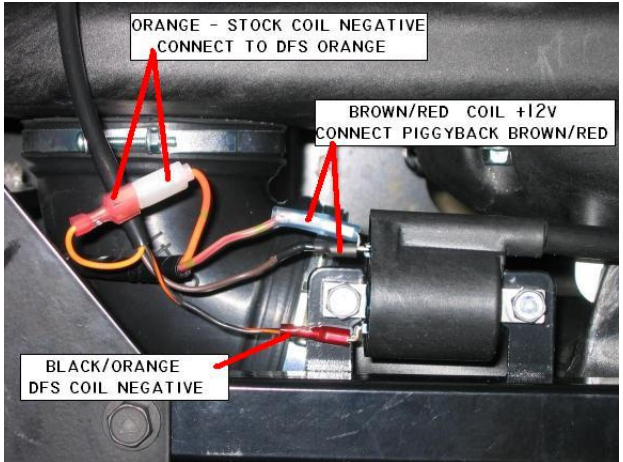

Picture 5:

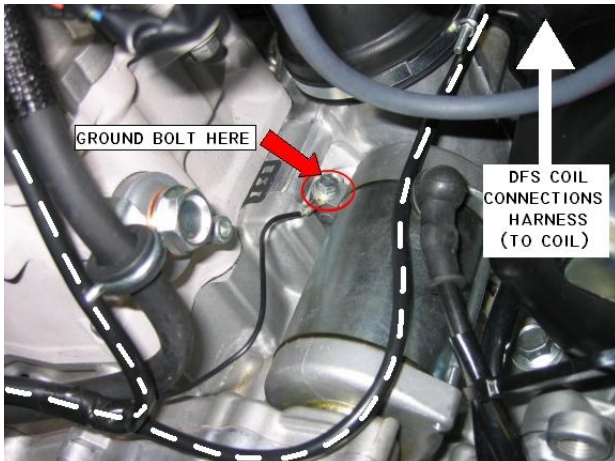

Picture 6:

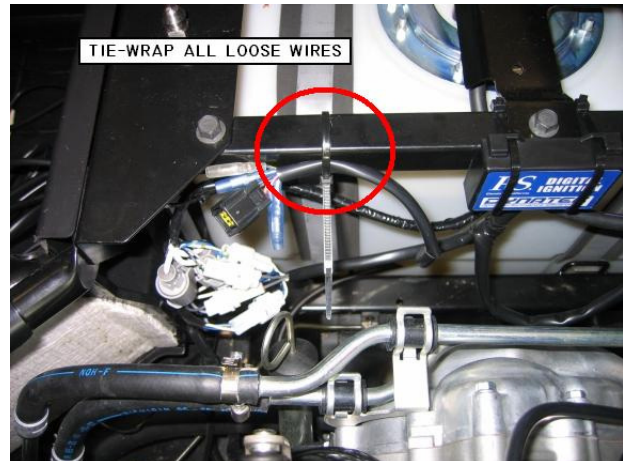

Using the DRSP-1 Remote Serial Programmer

The DRSP-1 Remote Serial Programmer (sold separately) for the Rhino 700 is a plug-in programmer for adjusting the fuel injection and ignition advance curves. Simply plug the DRSP-1 into the DFS HARNESS and mount the Remote to the vehicle's dashboard for easy access. The Remote allows adjustment to the stock fuel injections signal in multiple stages.

NOTE: It is HIGHLY RECOMMENDED to use a wide band oxygen sensor and quality gauge (such as Dynojet's Wide Band Commander) when tuning the fuel injection. Without a gauge, the air/fuel ratio cannot be determined and possible engine damage can occur.

FUEL BASE – this setting will adjust the entire fuel map: 1 = 0% 2 = +5% 3 = +10% 4 = -5%
FUEL LOW – this setting will adjust fuel from 0 rpm to 3,000 rpm, in the ranges of: -17.5% to 0% to +20%
FUEL MID – this setting will adjust fuel from 3,001 rpm to 6,000 rpm, in the ranges of: -17.5% to 0% to +20%
FUEL HIGH – this setting will adjust fuel from 6,001 rpm to 10,000 rpm, in the ranges of: -17.5% to 0% to +20%
IGN CURVE – this setting will adjust the Ignition Curve, up to 4 selectable and all can be custom programmed using the CurveMaker Software. (see attached Curve Chart)

NOTE: The DRSP-1 can be removed after adjusting the settings, and the DynaFS will keep the settings even with the battery disconnected. If the LED on the Remote does not turn on, or the LED flashes continuously after 10 seconds, then the ignition and Remote should be returned to Dynatek for testing.

Additional Features

The DFS for the Rhino 700 has many additional features. These are pre-programmed and they all can be accessed using Dynatek CurveMaker Software (not supplied with the ignition). If the ignition was not purchased directly from Dynatek, the dealer may have programmed a custom set of ignition curves and fuel injection settings. The dealer should be consulted with any questions regarding the curves and settings that are programmed into the ignition.

The DFS ignition for the Yamaha Rhino 700 has a Vehicle Speed Limit set to 100 MPH. This vehicle speed limiter is independent from the 8,000 RPM engine speed (RPM) limiter, and is adjustable in the CurveMaker software from 5 to 199 MPH. This limiter will be activated every time the vehicle speed matches this number while in Forward Lo, in Forward Hi or in Reverse gear.

The DFS ignition for the Yamaha Rhino 700 is shipped with additional leads coming out of the ignition. These leads allow the ignition to control other features. To program these features, follow the instructions in the programming kit.

PURPLE/WHITE – Programmable Safety Vehicle Speed Limit. Ground this wire to activate, preset at 15 MPH (5-199 MPH adjustable using CurveMaker software)

BLACK/YELLOW – Programmable Launch Limiter. Ground this wire to activate, preset at 3,200 RPM (0-10,000 RPM adjustable using CurveMaker software)

BLUE – Optional 2-amp RPM window activated switch to ground, referenced as "RPM Switch 1" in PC Software.

WHITE/BLUE – Optional 2-amp RPM window activated switch to ground, referenced as "RPM Switch 2" in PC Software.

The Blue and White/Blue wires are 2-amp switches that can be used to activate a solenoid or relay. Connect the relay with hot +12v wired to one side of the relay coil, and the other side connected to Blue or White/Blue. When the rpm activates the switch, it will be grounded inside the ignition box, causing current to flow through the relay coil. DO NOT connect any device which requires more than 2 Amps (Amps=Volts/Resistance). See attached wiring diagram for wiring the relay.

Data Recording

The DFS7-26 for the Rhino 700 will continuously record important engine operating parameters. This information can only be accessed through the Dynatek CurveMaker in the Diagnostics Tab of the software (sold separately). The recorded data includes:

Number of Engine Starts (recorded after 2.25min of run time)	Histogram Barchart of Engine Speed VS. Time
Total Time Engine at WOT (hours)	Maximum Engine Speed
Total Operating Time (hours)	Time Near Rev Limit
Longest Continuous WOT Operation (seconds)	Programmed Rev Limit

Troubleshooting

Troubleshooting the Dyna ignition is simple. If the dashboard "Check Engine Light" is ON, or the vehicle will not start or run at all, follow these 3 steps:

- 1) Disconnect the Fuel Injector Intercept connectors and reconnect the stock connector to the fuel injector,
- 2) Disconnect the BROWN/RED piggyback lead at the ignition coil, and reconnect the stock +12v BROWN/RED lead to the coil positive (this removes +12v source from the DFS),
- 3) Disconnect the DFS ORANGE/BLACK coil negative wire, and reconnect the stock ORANGE wire back to the ignition coil negative.

If this fixes the problem, then the Dyna ignition should be returned to Dynatek for testing. If this does not fix the problem, then the problem is somewhere else on the engine or vehicle. Follow the troubleshooting procedures outlined in your vehicle shop manual.

If you are using non stock spark plug, or stator, replace them with OEM units. Then follow the procedures in the calibration section to set the Dyna ignition up to work with your vehicle. If calibration doesn't fix the problem, the ignition should be returned for testing. If the problem persists when using the stock ignition then the problem is external to the Dyna ignition.

Examples of RPM Activated Switch wiring:

SHIFT LIGHT or SMALL SOLENOID

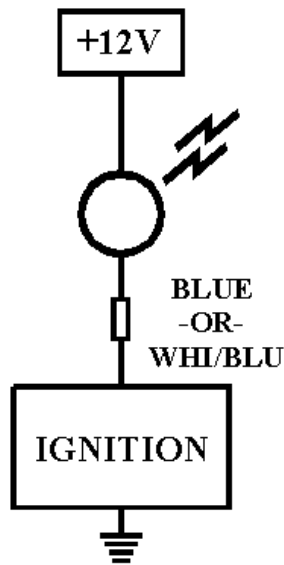

USING A BOSCH STYLE RELAY TO SWITCH HEAVY LOADS

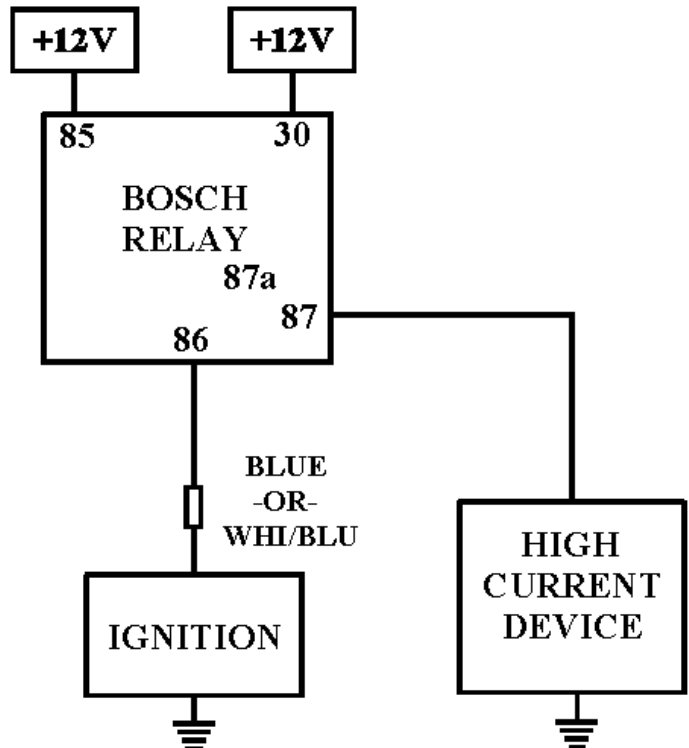

DYNA FS 7-26 / YAMAHA RHINO 700 - IGNITION CURVES

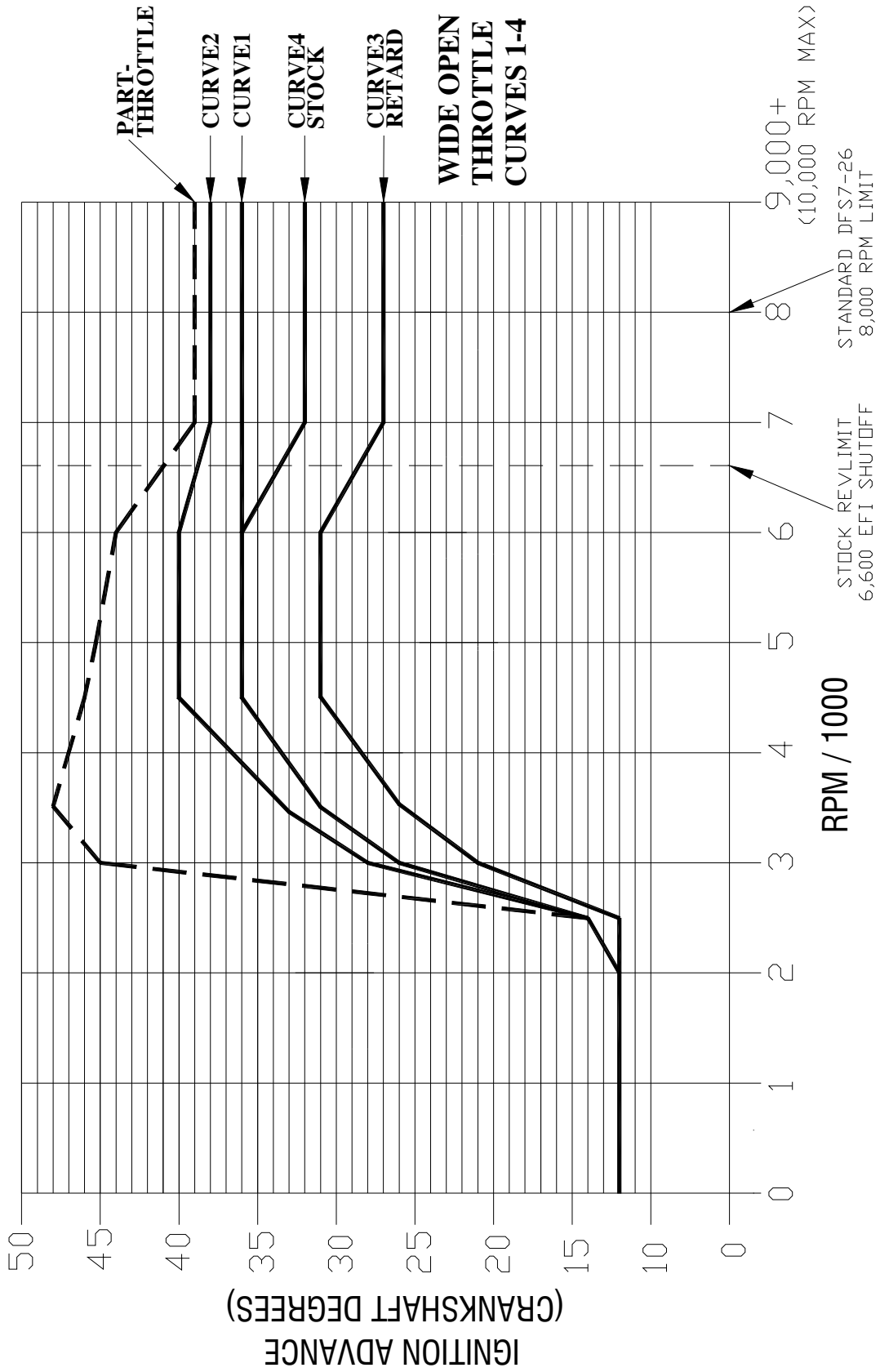

ALL BASE MODULES USE CURVE 2

CURVE 4 = STOCK ADVANCE

(Chart Includes Static 12° Base Timing)

DYNATEK	
164 S. VALENCIA ST., GLENDORA, CA 91741 (800)228-3962	
TITLE RHINO 700 ADVANCE CURVES	
DATE 5-22-08	MODEL 2008+ RHINO 700
REV 1.0	